

CATALOGO TRAFILE

DIES CATALOGUE
CATALOGUE FILIÈRES
CATALOGO TREFILADORAS

PER I SEGUENTI MODELLI:
FOR THE FOLLOWING MODELS:

DIAMETRO TRAFILA
56MM

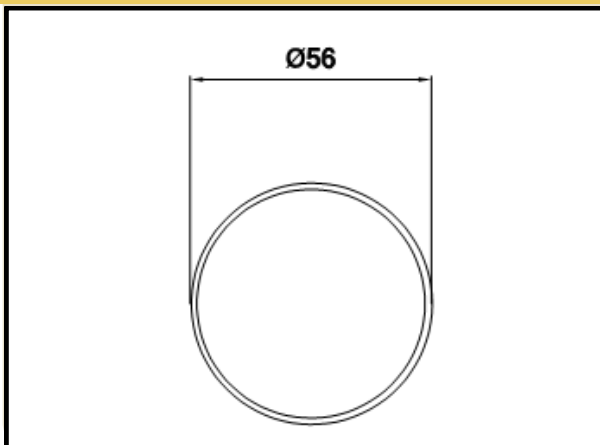

MPF 1,5N
FATTORINA
PF15E

PER I SEGUENTI MODELLI:
FOR THE FOLLOWING MODELS:

MPF 2,5N
MPF 4N
PF25E
PF40E
VIP 2
VIP 4

DIAMETRO TRAFILA
63MM

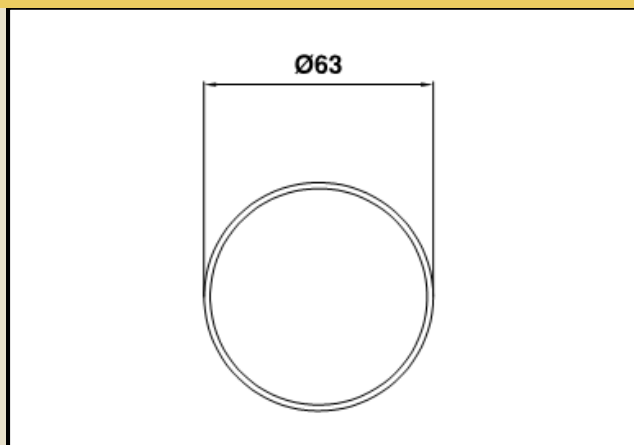

CATALOGO TRAFILE - DIES CATALOGUE - CATALOGUE FILIÈRES - CATALOGO TREFILADORAS

**CAPELLI
D'ANGELO**

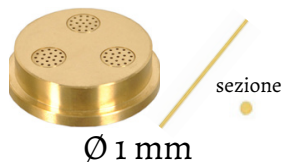

SPAGHETTI 1,5

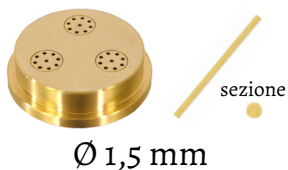

SPAGHETTI 2

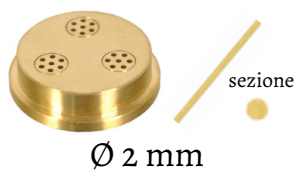

BIGOLI

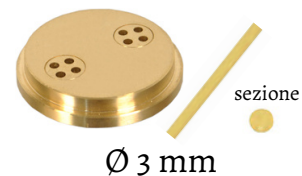

**PICI TOSCANI /
SPAGHETTONI 4**

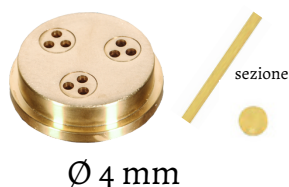

**SPAGHETTI
ALLA CHITARRA**

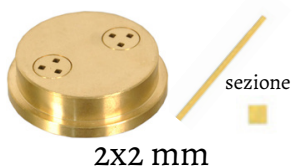

GRAMIGNA

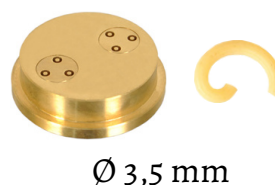

BUCATINI

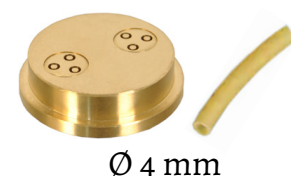

LINGUINE 3*1,6

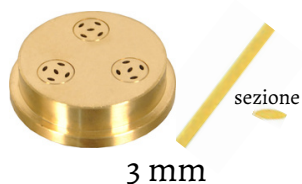

LINGUINE 4*1,6

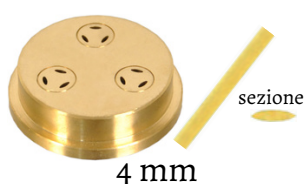

TAGLIOLINI

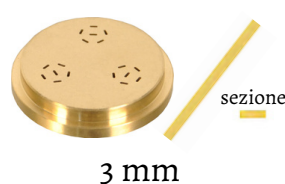

TAGLIATELLE

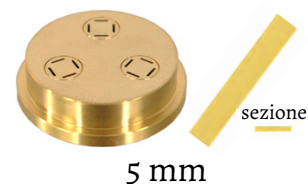

FETTUCCINE

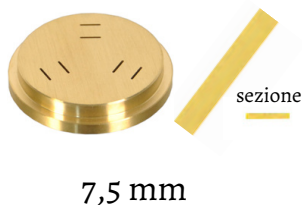

PAPPARDELLE

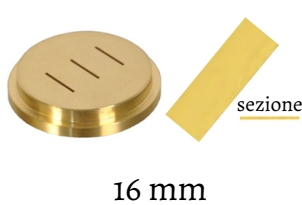

**PAPPARDELLE
RICCE**

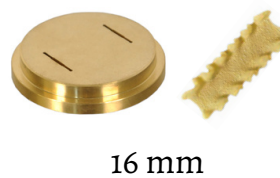

SFOGLIA
PASTA SHEET/LASAGNA



SCIALATIELLI



5x3 mm

CASERECCE



9x5 mm

**CONCHIGLIE
RIGATE**



32,5 mm

**GNOCCHETTO
SARDO**



19 mm

FUSILLI 2P



Ø 13 mm

FUSILLI 3P



Ø 9 mm

FUSILLI 5P



Ø 20 mm

ORECCHIETTE



22 mm

**MACCHERONI
4,8**



Ø 4,8 mm

**MACCHERONI
8,5**

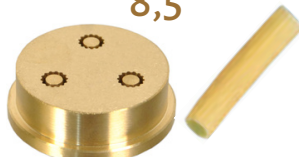

Ø 8,5 mm

**MACCHERONI
15**



Ø 15 mm

**TROTTOLA
LISCIA**



12 mm

CANNELLONE



Ø 25 mm

PACCHERI

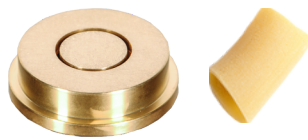

Ø 25x1,5 mm

CANESTRINI



Ø 16 mm

**RUOTE
RIGATE**



Ø 12 mm

STELLINE



5 mm

RADIATORI



26 mm

RISO



7 mm

RECHTA



1,5x0,6 mm

GNOCCHI

Solo con farina di patata liofilizzata
Only with freeze-dried potato flour



Ø 12 mm

PENNE RIGATE

*disponibili solo di Ø56
*only Ø56 available



Ø 9 mm